



The World's **Sixth Sense**<sup>®</sup>

# Fido<sup>®</sup> X4

## Handheld Explosives Trace Detector

### Operations Manual



## **COPYRIGHT**

Copyright 2020 FLIR Systems, Inc.  
April 2020

This documentation is provided as a component part of the Fido® X4 detection system. All parties or individuals in possession of the documentation accept in full and without exception or limitation the FLIR Systems, Inc. unrestricted rights of ownership of this material. This documentation is not available by any other means except license which is only available from FLIR Systems, Inc. Under no circumstances may any part or the whole of this documentation be reproduced, stored in a retrieval system, transmitted, copied, modified, distributed, displayed, sold, licensed, published, or derivative works created therefrom in any form or by any means: electronic, mechanical, recording, or otherwise, without the written permission of FLIR Systems, Inc. obtained in advance of the requirement.

It is expressly forbidden for the holder of this documentation to use it either in its entirety or in part or any graphics to provide training or tuition, assistance or knowledge transfer to any other party whatsoever or for marketing of promotional literature or material of any type whatsoever without the prior written permission of FLIR Systems, Inc. Use of this documentation in any manner inconsistent with the user manual and related documentation is strictly prohibited. Use of the documentation is not transferable.

## **WARRANTY**

The Fido X4 equipment that is the subject of this manual is covered by a standard warranty. The terms of the warranty are defined by the "Terms and Conditions of Sale" that was in effect at the time of purchase. A copy of this document can be obtained through your FLIR Systems sales channel for Detection Products.

## **TRADEMARKS**

Product name and any design elements are trademarks of FLIR Systems, Inc. All other product and company names may be the property of their respective owners Specifically:

- Windows® is a registered trademark of Microsoft Corporation.
- Mac® is a registered trademark of Apple Inc.
- Linux® is a registered trademark of The Linux Foundation.

## **PATENTS**

Protected by one or more patents and patent applications.  
Learn more here: [www.flir.com/patentnotice](http://www.flir.com/patentnotice).

## **EXPORT CONTROL**

**WARNING:** This document contains technology whose export, re-export, or transfer to Non-U.S. Persons, wherever located, is subject to the Export Administration Regulations (EAR) (15 C.F.R. Sections 730-774). This document may not be exported, reexported, or transferred without the prior authorization of the U.S. Department of Commerce.

## **PROPRIETARY INFORMATION**

This documentation contains confidential and proprietary information that must be maintained in confidence and used only in a manner consistent with the documentation and may not be disclosed to any third parties.

[www.flir.com/detection](http://www.flir.com/detection)

**Tel (Toll-free):** +1.877.692.2120

FLIR Detection, Inc.  
1024 S. Innovation Way  
Stillwater, OK 74074  
USA

**Tel:** +1.405.372.9535

**Fax:** 1.405.372.9537

### **Asia/Pacific**

FLIR Detection, Inc.  
3 Pickering Street #03-49  
Nankin Row  
Singapore 048660

**Tel:** + 65.6822.1595

### **Europe, Africa, Middle East**

FLIR Detection, Inc.  
Luxemburgstraat 2  
2321 Meer  
Belgium

**Tel:** + 32 (0) 3665.5106

**Fax:** + 32 (0) 3303.5624

# Table of Contents

<b>1 Introduction</b> .....	<b>9</b>
1.1 Technical Support .....	9
<b>2 Safety</b> .....	<b>11</b>
2.1 Safety Conventions and Labeling .....	11
2.1.1 Label types.....	11
2.1.2 Safety symbols.....	11
2.2 Wireless Capability Compliance Notices .....	12
2.2.1 FCC Interference Statement (Part 15.105 (a)).....	12
2.2.2 FCC Part 15 Clause 15.21 [Do not modify warning].....	12
2.2.3 FCC Part 15.19(a) [Interference compliance statement].....	12
2.2.4 ISED RSS-Gen Notice.....	12
<b>3 System Overview</b> .....	<b>14</b>
3.1 Theory of Operation .....	14
3.2 Fido X4 System Kit Contents .....	14
3.3 Fido X4 Unit Overview .....	16
3.4 Primary Hardware Components .....	17
3.4.1 Thermal desorption module (TD).....	17
3.4.2 Detector inlet.....	17
3.4.3 Display.....	18
3.4.4 Keypad.....	18
3.4.5 USB-C port .....	18
3.4.6 Battery.....	18
3.4.6.1 Soft button .....	18
3.5 Primary consumable components .....	18
3.5.1 Sensing element .....	19
3.5.2 Sample swipes.....	20
3.5.3 Reference standard.....	20
<b>4 Getting Started</b> .....	<b>22</b>
4.1 The Keypad .....	22
4.1.1 Overview.....	22
4.1.2 Using the Input Keys.....	22
4.1.2.1 Enter key .....	22
4.1.2.2 Menu key .....	23
4.1.2.3 Back key .....	23
4.1.2.4 Directional pad .....	23
4.2 Fido X4 Menus .....	25

---

4.2.1 Sensitivity menu .....	25
4.2.2 Settings menu .....	26
4.2.2.1 Scroll bars on menu screens .....	27
4.2.3 Clean System Menu .....	27
4.2.4 File Archive Menu .....	27
4.2.5 Device Status menu .....	28
4.2.6 Help .....	29
<b>5 Operating the Fido X4 .....</b>	<b>30</b>
5.1 Fido X4 Power On Sequence .....	30
5.1.1 Startup .....	30
5.1.2 Heating Up .....	30
5.1.2.1 Startup Wizard .....	31
5.2 Verifying the System .....	31
5.2.1 Verification Failure .....	34
5.2.1.1 Reference Presentation Error .....	35
5.3 Collecting a Particulate Sample .....	35
5.3.1 Trace detection .....	35
5.3.2 What to sample .....	35
5.3.3 How to sample .....	36
5.4 Collecting a Vapor Sample .....	39
5.4.1 Vapor Detection Mode .....	39
5.4.2 Vapor Mode settings .....	39
5.4.3 Switching to Vapor Mode .....	40
5.4.4 Verifying the system in Vapor Mode .....	40
5.4.5 Collecting a vapor sample .....	42
5.4.5.1 Sample .....	42
5.4.5.2 Search .....	42
5.5 Sample Information .....	43
5.5.1 Sample information: no threat detected .....	43
5.5.2 Sample information: threat detected .....	44
5.5.3 DATA command .....	45
5.5.4 FLAG command .....	45
5.5.5 ID command .....	46
5.6 Turn Off the Fido X4 .....	46
<b>6 Reviewing Data .....</b>	<b>47</b>
6.1 Reviewing Sample Data .....	47
6.1.1 Reviewing individual sample records .....	47
6.2 Creating Reports .....	48
6.2.1 Erasing data .....	50

---

<b>7 Connecting to a Computer</b>	<b>51</b>
7.1 USB Connection	51
7.2 Wireless Connection	51
7.3 Updating Firmware	51
7.4 Reports	51
7.5 Digital manuals	52
<b>8 System Maintenance</b>	<b>53</b>
8.1 Replacing the Sensing Element	53
8.1.1 Removing the sensing element	53
8.1.2 Installing the sensing element	56
8.2 Battery Handling	57
8.2.1 Charging the battery	57
8.2.2 Replacing the battery	57
8.2.2.1 Removing the battery	57
8.2.2.2 Installing the battery	57
8.3 Maintenance Kit Contents	57
8.4 Removing and Attaching the Thermal Desorber	58
8.4.1 Removing the thermal desorber	58
8.4.2 Attaching the thermal desorber	58
8.5 Replacing the Detector Inlet	59
8.5.1 Removing the inlet	59
8.5.2 Installing the inlet	59
8.6 Cleaning the System	60
8.6.1 Clean System menu	60
8.6.1.1 Power clean	60
8.6.1.2 Manual cleaning	60
8.6.2 Cleaning the thermal desorber	61
8.6.3 Cleaning a clogged or dirty sensor Inlet	61
8.6.4 Other maintenance tasks	62
8.6.4.1 Inspecting and replacing O-rings	62
8.6.4.2 Checking the system for leaks	62
<b>9 Understanding Alerts</b>	<b>63</b>
9.1 Don't Panic	63
9.2 Confirm and Investigate	63
9.3 Follow Organizational Protocols	64
<b>10 Specifications</b>	<b>65</b>
<b>Table of Figures</b>	<b>67</b>

---

**Index** ..... **69**



# 1 Introduction

This manual describes the proper operation and maintenance of your Fido X4 System.

The FLIR Fido® X4 is a lightweight, hand-held explosives trace detector (ETD), designed for extended daily use for Entry Control Point (ECP) security screening applications. The system is ultra-portable, weighing just 3.2 pounds (1.45 kg), and includes two 8-hour rechargeable and hot-swappable lithium ion (Li-Ion) batteries, making it ideal both for fixed site checkpoints and for dynamic security environments where trace detection is needed at many changing locations.

Fido X4's award-winning TrueTrace® technology detects unseen threats with higher sensitivity and faster clear-down time compared to similar products. Fido X4 delivers fast, cost-effective, high throughput screening with sampling time of 10 seconds or less and alarm results displayed in under 25 seconds from sample presentation. System clear-down is complete in an average of less than 30 seconds from alarm result.

The Fido X4 is available as a complete system kit, to include the Fido X4 handheld ETD, spare battery, basic accessories, maintenance kit and starting quantities of consumables. For a detailed description of kit components, see "System Overview" on p. 14.

## 1.1 Technical Support

This manual is only one of the ways you can learn about the Fido X4. Each Fido X4 kit purchase includes operator training and access to FLIR Detection's customer service portal. Register your system at <https://flir.link/x4/> for access to:

- Product notifications
- Technical bulletins
- Firmware updates
- Additional consumables and accessories
- Return merchandise authorizations (RMA)
- Technical support
- Training

There are multiple training options, including in-person courses at FLIR's Stillwater, OK facility and online training courses. The Fido X4 device also contains instructional videos that can be viewed on demand.

Use the information in this manual and at FLIR's customer service portal to help your Fido X4 function properly for years to come.

## Contact Information

<https://detectionsupport.com/explosives/>

**email:** [explosives.support@flir.com](mailto:explosives.support@flir.com)

**Tel (Toll-free):** +1.877.692.2120



## 2 Safety

### IMPORTANT:

Before operating the Fido X4, you must read, understand, and follow all instructions, warnings, cautions, and legal disclaimers.

### 2.1 Safety Conventions and Labeling



This section describes the safety labels and symbols used in this manual. Failure to observe these safety indicators could result in operator injury or system damage. In addition, the system may not operate as intended.

#### 2.1.1 Label types

The following levels of safety labeling may be used in this document:

<b>Warning</b>	Indicates an imminently hazardous situation that may result in death or serious injury.
<b>Caution</b>	Indicates a potentially hazardous situation that may result in injury or equipment damage.
Note	Directs attention to important information you should review before proceeding with system operation.

#### 2.1.2 Safety symbols

Symbol	Meaning	Action to Take
 <p>Caution: Battery Handling</p>	<p>Device contains battery. Handle batteries appropriately.</p>	<ul style="list-style-type: none"> <li>• Use specified charger only.</li> <li>• Do not incinerate or expose to high temperatures above 140°F / 60°C.</li> <li>• Do not short-circuit.</li> <li>• Do not put into fire. Dispose of properly.</li> </ul>
 <p>Caution: Burn Hazard - Hot Surface</p>	<p>The sensing element, detector inlet, reference standard and other components inside the thermal desorber are heated or may become heated during operation and may cause burns.</p>	<ul style="list-style-type: none"> <li>• Avoid direct skin contact to hot surfaces while the Fido X4 is on and for three minutes after it is turned off.</li> </ul>

Symbol	Meaning	Action to Take
 <p data-bbox="412 426 557 520">Caution: Broken Glass Hazard</p>	<p data-bbox="613 262 964 541">The Fido X4 sensing element (SE) is made of glass and can break if mishandled while being removed, installed, transported, or stored. Breaking a sensing element will create sharp edges and glass shards that can cut or puncture skin.</p>	<ul data-bbox="1013 262 1507 541" style="list-style-type: none"> <li>• Do not store sensing elements in clothing pockets.</li> <li>• Do not put a sensing element where someone might sit or step on it.</li> <li>• Properly dispose of used or broken sensing elements with care to avoid injury.</li> </ul>

## 2.2 Wireless Capability Compliance Notices

### 2.2.1 FCC Interference Statement (Part 15.105 (a))

This equipment has been tested and found to comply with the limits for a Class A digital device, pursuant to part 15 of the FCC Rules. These limits are designed to provide reasonable protection against harmful interference when the equipment is operated in a commercial environment. This equipment generates, uses, and can radiate radio frequency energy and, if not installed and used in accordance with the instruction manual, may cause harmful interference to radio communications. Operation of this equipment in a residential area is likely to cause harmful interference in which case the user will be required to correct the interference at his own expense.

### 2.2.2 FCC Part 15 Clause 15.21 [Do not modify warning]

Changes or modifications not expressly approved by the party responsible for compliance could void the user's authority to operate the equipment.

### 2.2.3 FCC Part 15.19(a) [Interference compliance statement]

This device complies with part 15 of the FCC Rules. Operation is subject to the following two conditions: (1) This device may not cause harmful interference, and (2) this device must accept any interference received, including interference that may cause undesired operation.

### 2.2.4 ISED RSS-Gen Notice

This device complies with Industry Canada's licence-exempt RSSs. Operation is subject to the following two conditions:

(1) This device may not cause interference; and

(2) This device must accept any interference, including interference that may cause undesired operation of the device.

Le présent appareil est conforme aux CNR d'Industrie Canada applicables aux appareils radio exempts de licence. L'exploitation est autorisée aux deux conditions suivantes:

- 1) l'appareil ne doit pas produire de brouillage;
- 2) l'appareil doit accepter tout brouillage radioélectrique subi, même si le brouillage est susceptible d'en compromettre le fonctionnement.

## 3 System Overview

### 3.1 Theory of Operation

The primary concept of operation for the Fido X4 Handheld ETD is high throughput screening for trace explosives residues. The screening process consists of three basic steps:

1. Samples are collected from operational surfaces via reusable sample media (Sampling Swipes).
2. Samples are processed and analyzed by the Fido X4 through an automated sequence of sample desorption, sample introduction, and signal processing.
3. After a sample has been processed, the Fido X4 displays easy-to-interpret alarm results and threat identification information.

### 3.2 Fido X4 System Kit Contents

The Fido X4 System Kit includes the following:

- Welcome card
- Documentation
  - *Quick Start Guide*
  - Safety information document
  - Kit contents document
- Fido X4 Handheld ETD with battery installed
- Spare battery ( 1)
- Battery charging adapter
- AC power supply
- USB-C to USB-A data cable
- Fido X4 sensing elements
- Fido X4 sampling swipes
- Fido X4 reference standard
- Vapor Mode inlet adapter
- Maintenance kit
- Single-point harness
- Storage case

For a description of maintenance kit contents, see "System Maintenance" on p. 53.

Figure 3-1 shows the location of these items in the Fido X4 storage case.

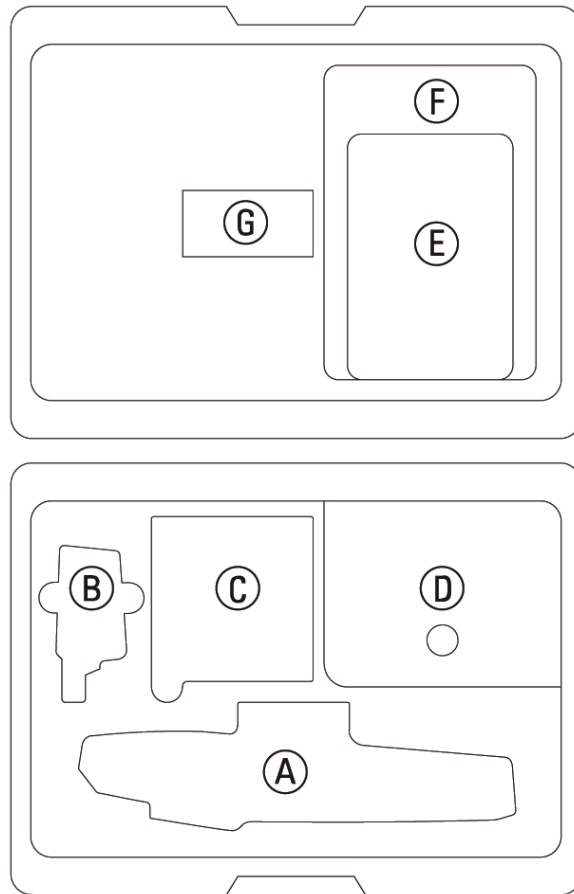

**Figure 3-1:** Fido X4 Kit Contents

- |  |  |
|--|--|
| <p>A Fido X4 Handheld ETD<br/>Battery charging adapter</p>             | <p>E Fido maintenance kit<br/>Vapor Mode inlet adapter<br/>X4 reference standard</p> |
| <p>B Spare battery</p>   | <p>F <i>Quick Start Guide</i></p>  |
| <p>C X4 consumables<br/>(Sensing elements and sampling<br/>swipes)</p> | <p>G Single-point harness</p>  |
| <p>D AC power supply<br/>USB-C to USB-A data cable</p>                 |  |

### 3.3 Fido X4 Unit Overview

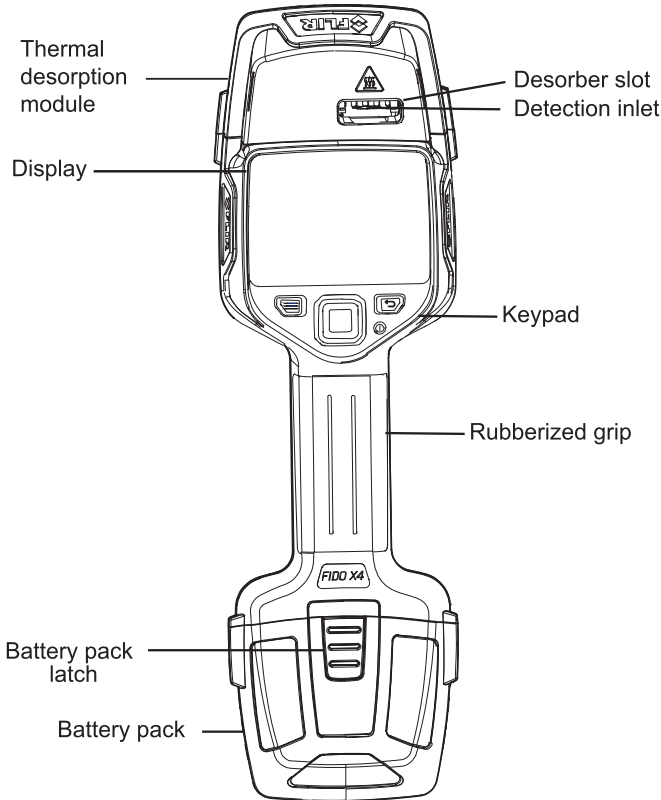

**Figure 3-2:** Fido X4 (front)



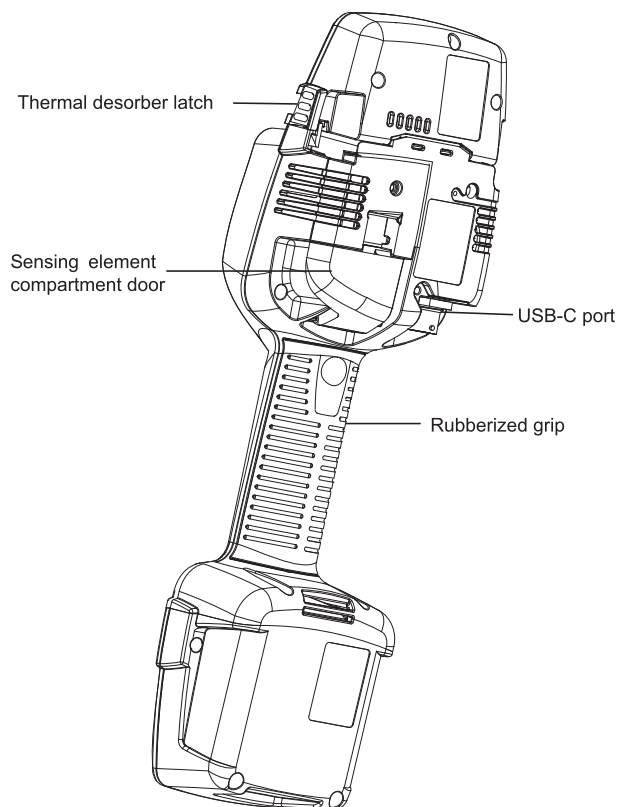

**Figure 3-3:** Fido X4 (back and right side)

## 3.4 Primary Hardware Components

### 3.4.1 Thermal desorption module (TD)

The primary function of the *thermal desorption module*, or *thermal desorber (TD)*, is to process trace particulate samples by heating a sample swipe, which vaporizes particulate material that was collected. When a sample swipe is inserted into the TD, the desorber automatically senses swipe insertion and mechanically positions the effective area of the swipe in close proximity to the detector inlet (3.4.2). Sample vapor is then drawn into the detector, where detection events can occur.

### 3.4.2 Detector inlet

The primary function of the *detector inlet* is to efficiently draw sample vapor into the system and across the sensor array. The detector inlet material is silica-treated stainless steel, which provides efficient heating and sample transport into the detector.

### 3.4.3 Display

The system display is a full color, daylight-readable LCD, which supports viewing and accessing all system functions. No additional software programs are required to operate the Fido X4 or to access system data.

### 3.4.4 Keypad

The system keypad contains the following buttons:

- Power button
- Menu button, for accessing system settings, functions and status
- Multi-directional pad for navigation within system menus
- Back button for reversing navigation

For more information, see "The Keypad" on p. 22.

### 3.4.5 USB-C port

The Fido X4 has one data port which can be used to connect the device to a PC. USB-C is a modern standard for Universal Serial Bus and is capable of powering the device and sending and receiving large amounts of data quickly. When connected to a PC, the Fido X4 behaves as any standard USB storage device, so data reports generated on the device can be easily transferred.

### 3.4.6 Battery

The Fido X4 is equipped with a lithium ion (Li-Ion) battery. The expected battery life under normal operating conditions is 8 hours. The battery is rechargeable while plugged into the device or also via an external battery charging adapter. The battery is also hot-swappable, which allows you to replace the battery during operation without powering the Fido X4 off, greatly reducing operational downtime.

#### 3.4.6.1 Soft button

The *soft button* is located underneath the handle/grip of the Fido X4. The function of the soft button is to capture screenshots from the device display to record detector behavior and alarm results, or for sharing with FLIR technical support for troubleshooting purposes. Screenshots are saved on the device and are included in data reports.

## 3.5 Primary consumable components

Before operation, consumables should be transported and stored inside of the hard-shell case. During operation, consumables should be stored inside packaging, prior to use. For long-term storage, FLIR recommends storing consumables inside their packaging, at room temperature.

### 3.5.1 Sensing element



**Caution:** To avoid burns, when handling the sensing element, take care only to touch the end of the element that is marked with a dot. See Figure 3-4.



**Caution:** Breaking a sensing element will create sharp edges and glass shards that can cut or puncture skin.

- Do not store sensing elements in clothing pockets.
- Do not put a sensing element where someone might sit or step on it.
- Properly dispose of used or broken sensing elements with care to avoid injury.

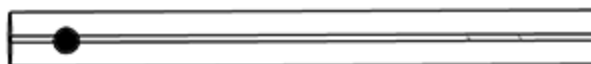

**Figure 3-4:** Sensing element (dot enlarged)

The Fido X4 *sensing element* contains the highly sensitive and selective fluorescent and chemiluminescent sensing materials that make-up TrueTrace technology. During operation, the unmarked end of the sensing element is inserted into the thermal desorber and heated.

The foundation of the sensing element is an optical-grade glass capillary tube. Sensing materials are applied as thin films, in a linear, 5-channel array, inside of the capillary. Multiple variations of these novel materials are used to achieve sensitivity and selectivity across a broad range of threat materials, including:

- nitroaromatics
- nitrate esters
- nitramines
- nitrosamines
- inorganic nitrate
- nitro-volatiles
- peroxides

Periodically, the sensing element must be replaced. During operation of the Fido X4, system diagnostics continually monitor sensor array performance to determine when replacement is needed. When the system determines that the sensing element must be replaced, simple prompts are displayed to inform the user. For more information, see "Replacing the Sensing Element" on p. 53.

Each sensing element lasts approximately 4-8 hours, although in some cases this time will be shorter or longer, depending on operating environment and sample type.

If sensing elements are stored properly in their packaging, their storage shelf life is guaranteed for one year. System diagnostics should always be used to determine the validity of the Sensing element. Sensing elements that have been removed from their packaging and left open to the environment for extended periods should be discarded.

### 3.5.2 Sample swipes

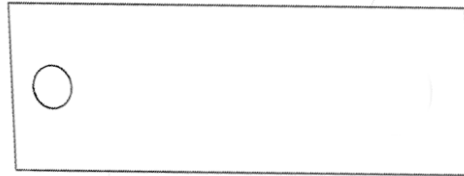

**Figure 3-5:** Sample swipe

Fido X4 Sample swipes are made of thin, thermally stable materials that are designed to efficiently collect particulate samples from operational surfaces, and also effectively allow desorption of those particles during sample processing.

Sample swipes can be reused. FLIR recommends that under normal operating conditions, swipes may be reused up to 10 times. However, there are some exceptions. If an alarm is recorded, which indicates the presence of explosive threat material, the swipe should be discarded or handled according to your alarm resolution protocols. Also, if a sample swipe becomes damaged during operation or becomes heavily soiled with dirt or debris, it should be discarded.

As long as they are stored properly in their packaging, sample swipes have an indefinite shelf life. Sample swipes that have been removed from their packaging and left open to the environment for extended periods should be discarded.

For more information, see "Collecting a Particulate Sample" on p. 35.

### 3.5.3 Reference standard

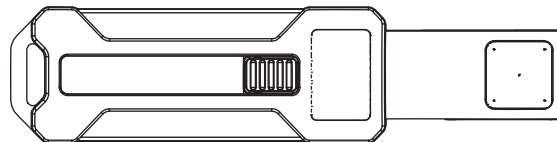

**Figure 3-6:** Reference standard, fully extended

The Fido X4 reference standard is a core element of the system diagnostic functions. Its purpose is to verify that system performance meets a predetermined threshold for detection of trace explosives. The reference standard contains a trace amount of explosive material designed to elicit a metered response across the sensor array, when processed. The retractable metal swipe element is designed to heat quickly, so that the reference dose is metered and consistent across the life of the reference standard.

Each reference standard should last for approximately 200 presentations. The storage shelf life for reference standards is guaranteed for 1 year.

For more information, see "Verifying the System" on p. 31.

**Note:** The reference standard is used to verify system response when detecting explosives in particulate form (Particulate mode). For information on verifying the system in Vapor Mode, see 5.4.4 on page 40.

## 4 Getting Started

This chapter describes some basic features of the keypad and display of the Fido X4.

### 4.1 The Keypad

#### 4.1.1 Overview

The Fido X4 has rubberized tactile input keys (Figure 4-1) located below the display.

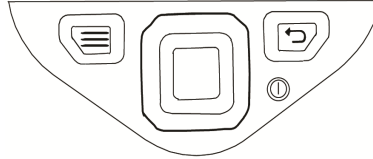



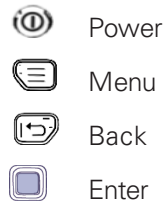

**Figure 4-1:** Keypad

In this manual, the following graphics will be used to indicate the input keys:





 Directional Pad. Press the outer edges of the Enter key to input the following commands:



-  Press top edge of Directional Pad Up
-  Press bottom edge of Directional Pad Down
-  Press left edge of Directional Pad Left
-  Press right edge of Directional Pad Right

#### 4.1.2 Using the Input Keys

##### 4.1.2.1 Enter key

Press  to select the highlighted or underlined menu, control, or command. In the example shown in Figure 4-2, **Info** is underlined, meaning you would press  to display an information screen..

#### 4.1.2.2 Menu key





Use  from most screens to bring up the Fido X4's Main Menu. If the Main Menu is already open, pressing  will exit the menu and return to the active operational screen. For more information, see "Fido X4 Menus" on p. 25.

#### 4.1.2.3 Back key

Use  to return to the previous screen or menu.

#### 4.1.2.4 Directional pad

##### *On command screens*

Use  on Command screens (see Figure 4-2) to move the cursor left () or right () to the next command. For example, in Figure 4-2 you would press  to highlight the **Help** command.



**Figure 4-2:** Example of a Command screen

**On menu screens**



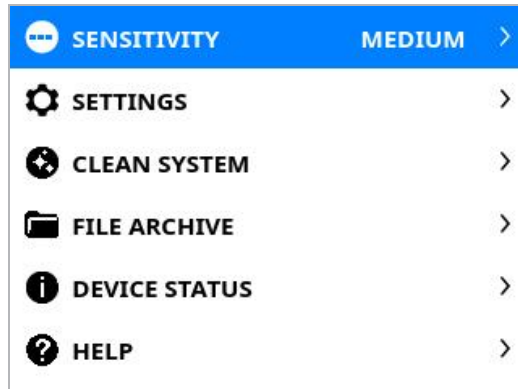

Use  on Menu screens to move the cursor up () or down () to the next menu option.



**Figure 4-3:** Example of a Menu screen

**On configuration screens**

In screens like the ones shown in Figure 4-4:

-  Increases the highlighted numerical value or changes to the next entry above.
-  Decreases the highlighted numerical value or changes to the next entry below.
-  In a multi-item configuration screen (see Figure 4-4, R), highlights the next selectable item to the left.
-  In a multi-item configuration screen, highlights the next selectable item to the right.



**Figure 4-4:** Examples of configuration screens



## 4.2 Fido X4 Menus



Press  to display the main menu of the Fido X4. The selections on the main menu represent primary system functions.

Each entry on a menu screen has its name in bold text near the left edge of the screen. Some menu entries include an icon to the left of the menu name as an additional visual cue.

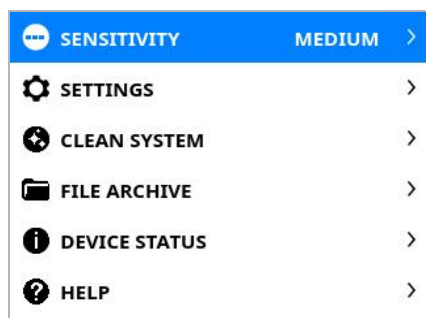
Some menu entries will have an arrow icon near the right edge, indicating that this menu item takes you to more options when selected.



**Figure 4-5:** Fido X4 main menu

- Press  or  to highlight the next menu entry above or below.
- Press  to select the highlighted entry and display its destination.

The following options are available from the main menu of the Fido X4:

### 4.2.1 Sensitivity menu

Select **Sensitivity** from the main menu to display the Fido X4 sensitivity level options. These options are designed to allow you to strike the right balance for your operation between Probability of Detection (PD) and False Alarm Rate (FAR).

- **High:** When high sensitivity is selected, the detection response thresholds on the system are adjusted to be lower. Use this setting when a high PD is your primary operational objective and where an increase in FAR is acceptable.
- **Medium:** Medium sensitivity offers an optimized balance between PD and FAR. FLIR recommends you use this setting for most operational applications.
- **Low:** Low sensitivity prioritizes False Alarm rejection. When you select low sensitivity, the detection response thresholds on the system are higher compared to when the system is in medium or high sensitivity mode.

A brief description of the highlighted sensitivity level is displayed at the bottom of the screen (Figure 4-6).





**Figure 4-6:** Sensitivity menu

## 4.2.2 Settings menu

Select **Settings** menu item from the main menu and press  to display the Settings menu (Figure 4-7).

**Note:** This section describes general system settings, so Vapor Mode settings are omitted. For a description of Vapor Mode settings, see 5.4.2 on page 39.

The Settings menu contains the following options:

- **Vibrate Enable:** The Vibrate Enable function is a toggle, meaning you can press  to turn it ON or OFF. Vibrate Enable lets you control the vibration feature associated with Alarm results. Turning on vibration gives you extra feedback when Alarms occur, in addition to on screen display and audible alarms.
  - Note the Vibrate Enable and Audio Enable features are independent of each other, allowing you to choose the right kind of feedback for operational environments where audible alarms are undesirable.
- **Audio Enable:** This function is also a toggle. Press  to turn audible alarms ON or OFF.
- **Audio Volume:** Select this option to go to a configuration screen where you can adjust the volume of audio alarms.
- **Backlight:** Select this option to go to a configuration screen where you can adjust screen brightness to the desired level.
- **Threat Table:** The Threat Table option takes you to a glossary of substances that are detected by the Fido X4. For examples of the kind of information that is displayed in the threat table, see "ID command" on p. 46.
- **Verify System:** This function allows you to manually activate a verification sequence. You can use this function at any time to confirm system performance. The verification sequence is described in "Operating the Fido X4" on p. 30.
- **Advanced Settings:** These settings require a passcode to access and are covered in the *Fido X4 Administrator's Guide*.

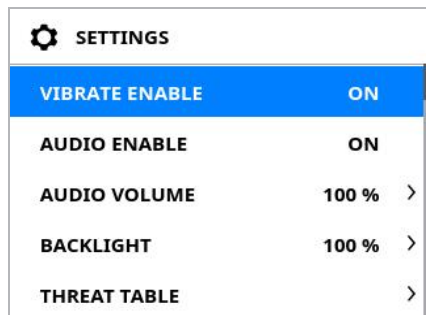

#### 4.2.2.1 Scroll bars on menu screens

Since the Settings menu (among others) cannot fit onto a single screen, a vertical scroll bar appears on the right edge of the screen (Figure 4-7).



**Figure 4-7:** Settings menu with scroll bar

The darker section of the scroll bar indicates the highlighted entry's current location in the multi-screen menu (in Figure 1-3, the darkened portion tells you that you are at the top of the menu).

- If a menu spans more than one screen, you can press  with the bottom entry highlighted to scroll to the next menu screen.
- Menus are multi-directional. Pressing  while at the top of the menu will automatically scroll to the bottom of the menu.

#### 4.2.3 Clean System Menu

For information on the Clean System menu, see "System Maintenance" on p. 53

#### 4.2.4 File Archive Menu

Functions on the File Archive Menu allow you to access historical information on samples that have been collected. For a detailed description of File Archive functions, see "Reviewing Sample Data" on p. 47.

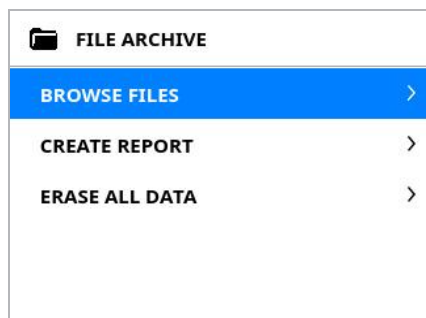

**Figure 4-8:** File Archive menu

#### 4.2.5 Device Status menu

Select the **Device Status** menu item from the main menu to access the following information about the Fido X4. The information on the Device Status menu is display only; you cannot modify it.

**Serial Number:** Each Fido X4 ETD can be identified using its unique serial number. All data stored on the device will include this serial number.

**Firmware Version:** The firmware version indicates the version of the software that is currently running on the system.

**Note:** The version of the detection algorithm installed on the device is independent from the firmware version.

**SE Type:** Indicated the type of sensing element installed in the system.

**SE Runtime:** The amount of time the current sensing element has been in the system with the system powered ON.

**System Runtime:** Total runtime for the system hardware.

**Detector Component Temperatures:** Current temperature for each detector hardware component. These values will flash red if they are out of range.

**Flow Rate:** The volumetric flowrate into the detector inlet and across the sensor array.



**Swipe Count:** Total number of samples swipes that have been processed.

**Disk Free:** The amount of free storage space remaining on the device.

i DEVICE STATUS	
SERIAL NUMBER	9971008
BETA FIRMWARE	0.91
SE TYPE	X4
SE RUNTIME	6 hr 15 min
SYSTEM RUNTIME	720 hr

**Figure 4-9:** Device Status menu

## 4.2.6 Help

Select **Help** from the main menu to display the **Help** menu, where you can access short instructional videos demonstrating how to perform tasks. Press  or  to highlight the video you want, then press  to play it.

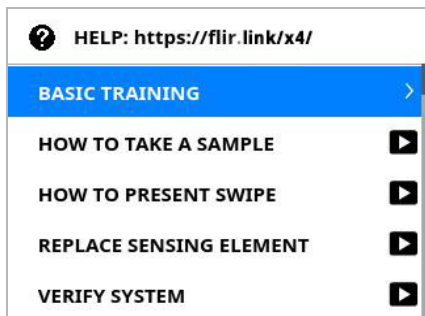

**Figure 4-10:** Help menu

## 5 Operating the Fido X4

### 5.1 Fido X4 Power On Sequence

Before powering on the Fido X4, ensure that a charged battery has been properly installed, and that all hardware components, such as the detector inlet and thermal desorber are connected. Also, ensure that a sensing element is installed in the system.

#### 5.1.1 Startup

To turn on the Fido X4, press and hold the power button, releasing when the display back-light becomes visible, which takes about three seconds. After several seconds, the first of several FLIR splash screens will appear. The startup process takes less than 30 seconds.



Figure 5-1:Startup screen

#### 5.1.2 Heating Up

After completing startup, the Fido X4 will heat the internal components. This process typically takes around three minutes but will vary somewhat based on the ambient temperature.



Figure 5-2: Heating Up screen

### 5.1.2.1 Startup Wizard

While the Fido X4 is heating, you may choose to play the Startup Wizard. The Startup Wizard is a series of short videos, without sound, which show the procedure for verification, sampling, and changing the sensing element. Press  during startup to begin the Startup Wizard.

## 5.2 Verifying the System

After the sensor has reached operating temperature and before operation begins, the Fido X4 requires verification. The system will display the message “Present Reference Standard.”

**Note:** For more information on the reference standard, see 3.5.3 on page 20.



**Figure 5-3:** Present Reference Standard screen

You can postpone the verification process for a short time by selecting **LATER**. However, the system will display a message which describes the effects of delaying verification.

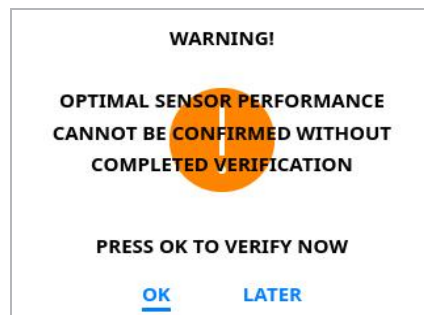
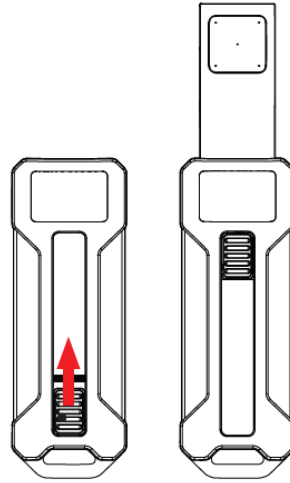

**Figure 5-4:** Incomplete verification warning

Follow the on-screen prompts or these instructions to perform the verification process.

Step 1: Remove a reference standard from the kit.

Step 2: Extend the reference standard from the sheath by pressing the thumb button while sliding it forward until the reference standard fully extends and locks.



**Figure 5-5:** Extending the reference standard

Step 3: With the holes facing toward the Fido X4 display, insert the reference standard into the thermal desorber (TD) slot as shown in Figure 5-6.

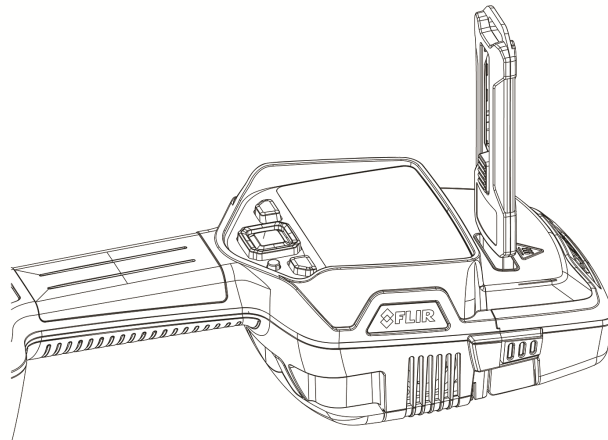

**Figure 5-6:** Reference standard in TD slot



Step 4: The TD slot will automatically close and the message “Checking System Performance” will be displayed along with a progress indicator.

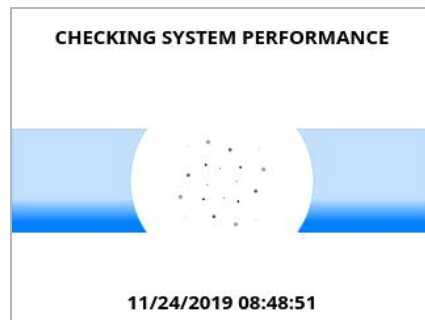

**Figure 5-7:** Checking System Performance screen



**Caution:** The metal portions of the reference standard can be HOT. Handle with care to avoid burns.

Step 5: When the TD slot opens, remove the reference standard.

Step 6: Close the reference standard by lightly pressing the thumb button and sliding until the extension is fully retracted back into the sheath.

Step 7: Store the closed reference standard in the kit.

Step 8: When analysis is complete, the Fido X4 will automatically display the result: “Verify Pass,” “Verify Fail,” or an error message will appear. If “Verify Pass” appears (Figure 5-8), select **OK**.

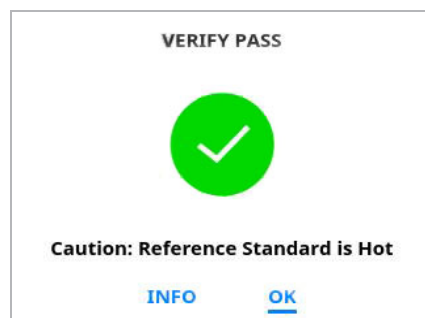

**Figure 5-8:** Verify Pass screen

### 5.2.1 Verification Failure

If a “Verify Fail” message appears, once the system has stabilized, you will be directed to do one of the following:

- Retry verification immediately with the same reference standard (Figure 5-10, L).
- Wait 60 seconds, then retry verification with the same reference standard. The screen will display a countdown (Figure 5-10, R).
- If verification continues to fail, you will be directed to replace the sensing element (Figure 5-11). For more information, see "Replacing the Sensing Element" on p. 53.



Figure 5-9: First Verify Fail screen

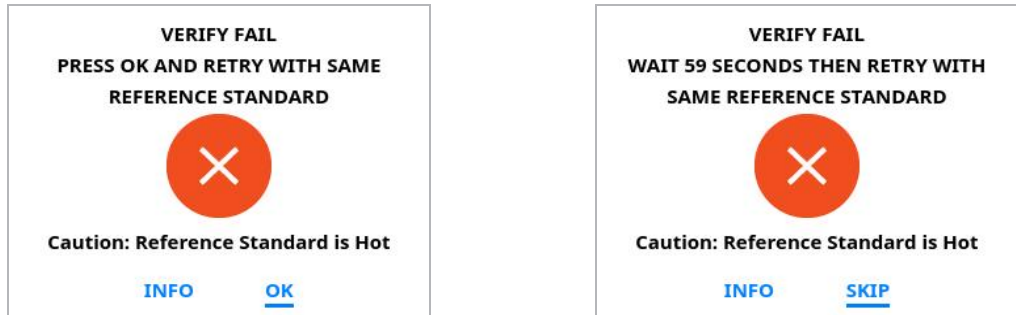

Figure 5-10: Verify Fail screens



Figure 5-11: Replace sensing element alert screen

### 5.2.1.1 Reference Presentation Error

If “Reference Presentation Error” appears, the most likely cause is that the thermal desorber malfunctioned or the reference standard was removed too early. Select **OK** to dismiss the message and retry the verification.

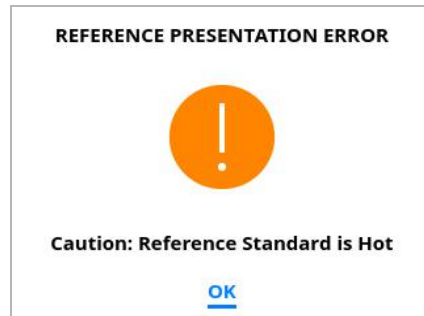

**Figure 5-12:** Reference Presentation Error screen

## 5.3 Collecting a Particulate Sample

### 5.3.1 Trace detection

The Fido X4 is designed for trace detection of explosive particulate. Trace is defined as an amount of a substance or chemical that cannot readily be seen by the naked eye. Substance quantities are often less than 1 microgram.

In order to detect trace amounts of explosives, it is important to collect the sample properly on the sampling swiipe and present the swiipe properly to the system. This section will provide guidance on how to properly locate and take a trace sample.

### 5.3.2 What to sample

Sample “first touch” areas. These are surfaces a person would often lift, slide, move, zip, tuck, press, or otherwise touch. Examples include bag fastenings and vehicle keys, door handles, and steering wheels.

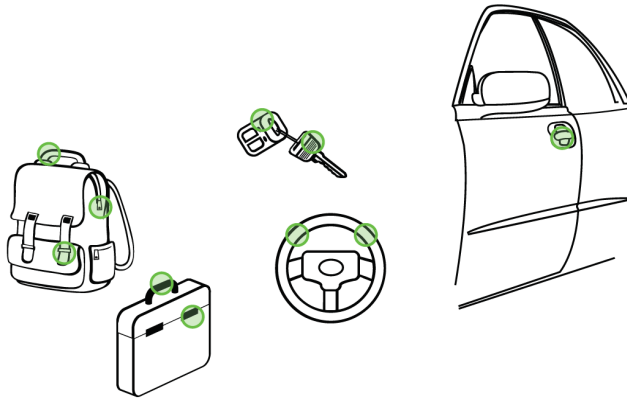

**Figure 5-13:** Examples of "first touch" areas

### 5.3.3 How to sample

**Step 1:** Remove a new sampling swipe from a package.

**Note:** A sampling swipe may be reused several times until any of the following occurs:

- an Alarm is recorded
- the swipe becomes visibly dirty
- the swipe becomes deformed or damaged

**Step 2:** Sample in the center of the bottom 1 in. (2.5 cm) square of the swipe as shown in Figure 5-14.

To sample, apply firm pressure (enough to bruise a tomato) to the back of the swipe with your index finger while dragging the swipe in a straight line across the surface being sampled. Lift the swipe when repositioning.

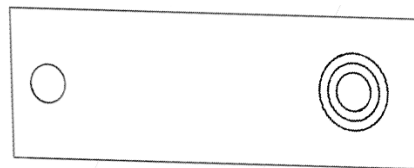

**Figure 5-14:** Bullseye design (not present on actual swipe) indicates Zone of Analysis

When swiping, ensure the full Zone of Analysis comes in contact with the surface being sampled. See Figure 5-15.

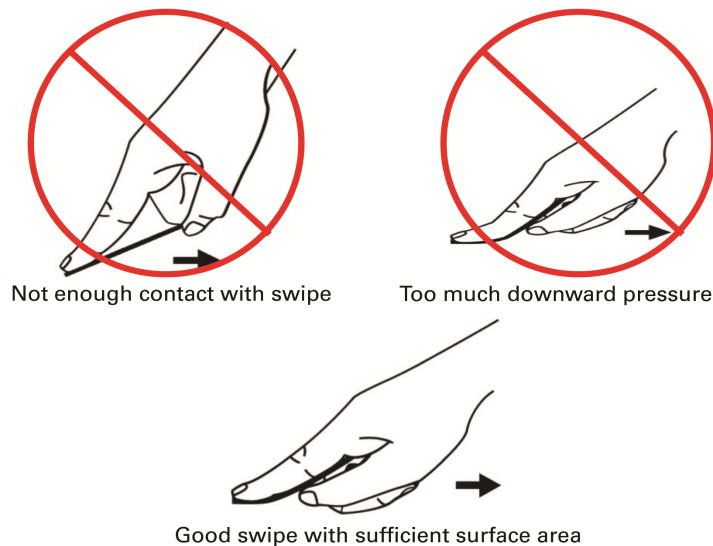

**Figure 5-15:** Examples of bad (top) and good (bottom) swiping technique

**Step 3:** Wait until the display prompts "Insert Sample" (Figure 5-16). Orient the swipe with the collected sample facing towards the screen of the device.



**Figure 5-16:** Insert Sample screen

**Step 4:** Insert the swipe into the thermal desorber (TD) slot until the swipe rests against the bottom stop and release. The TD will automatically close when the swipe is detected.

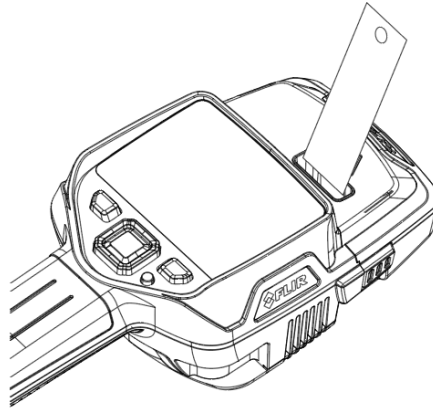

**Figure 5-17:** Sample inserted in TD Slot

Step 5: When the TD closes, the Fido X4 will display the message “Gathering Particles” (Figure 5-18) and a meter bar will appear to indicate sample progress.



**Figure 5-18:** Gathering Particles screen

Sampling lasts for a maximum of 10 seconds. If a response is detected sooner, the swipe will be released, and analysis will immediately begin.

Step 6: Follow the on-screen prompts and remove the swipe. The system will display the message “Analyzing particles” (Figure 5-19).

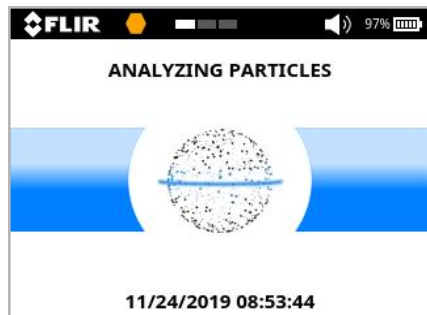

**Figure 5-19:** Analyzing Particles screen

Sample analysis will last for a maximum of 15 seconds. When complete, the system will display the result (Figure 5-20).

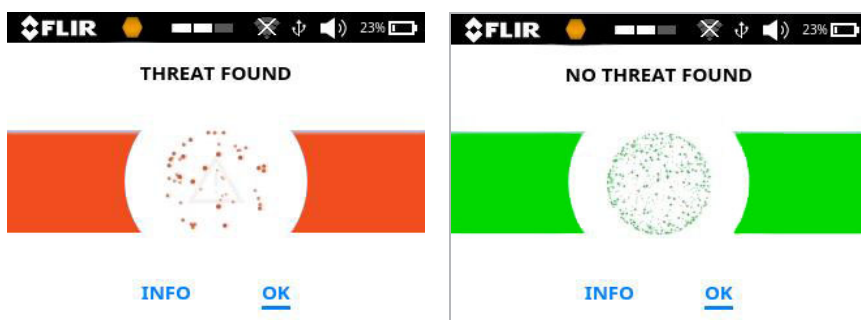

**Figure 5-20:** Analysis result screens

**Step 7:** Once the Fido X4 has displayed a result, you can select **OK** to acknowledge the response and return to the main menu or select **Info** to display information about the sample (see Figure 5.5).

## 5.4 Collecting a Vapor Sample

### 5.4.1 Vapor Detection Mode



The Fido X4 is capable of operating in two different sampling modes, Particle (see 5.3) Mode and Vapor Mode. While Particle Mode provides the most comprehensive means for threat detection based on various chemical and environmental principles, Vapor Mode provides some unique advantages for sampling and detecting specific threats with very high vapor pressures, or when contact with a sample is impossible. For example, liquids are difficult to sample using swipes, but the headspace above liquids can be sampled using Vapor Mode.

### 5.4.2 Vapor Mode settings

To access Vapor Mode settings:

Step 1: Press  to display the main menu (4.2).

Step 2: Select the **Settings** menu item and press  to display the Settings menu (Figure 5-10).

Step 3: Press  or  to scroll until you see the following Vapor Mode settings:

- **Vapor Method:** Use this setting to control which Vapor Mode detection methods are available for use. Options are Sample, Search, or Both. For more information, see 5.4.5.
- **Vapor Click:** This setting allows you to turn on or off audio feedback during vapor sampling.
- **Vapor Style:** When using the Search method of Vapor detection (5.4.5.2), this setting allows you to select the type of graph used to display channel responses.

### 5.4.3 Switching to Vapor Mode

To switch from Particle Mode to Vapor Mode, simply remove the thermal desorber. The Fido X4 will automatically detect the removal of the thermal desorber, and X4 system parameters, including key settings such as the temperature, flow, and detection algorithm, will be automatically adjusted. This process may take a few minutes.

### 5.4.4 Verifying the system in Vapor Mode

When the system is ready, it will require verification, which is similar to the process described in 5.2. The initial Vapor mode screen (Figure 5-21) plays a short video demonstrating how to present the Vapor Mode inlet adapter. As described in 5.2, you can select **Later** to postpone verification.

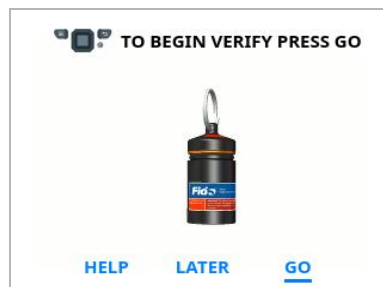
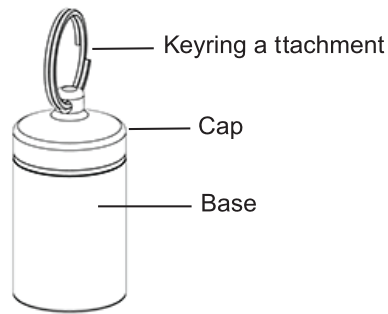

**Figure 5-21:** System verification screen for Vapor Mode

Follow the on-screen prompts or these instructions to perform the verification process:

Step 1: Remove the cap from the Vapor Mode inlet adapter (Figure 5-22) by twisting counterclockwise.





**Figure 5-22:** Vapor Mode inlet adapter

**Step 2:** Press the uncapped end of the inlet adapter against the exposed tip of the Detector inlet as shown in Figure 5-23.

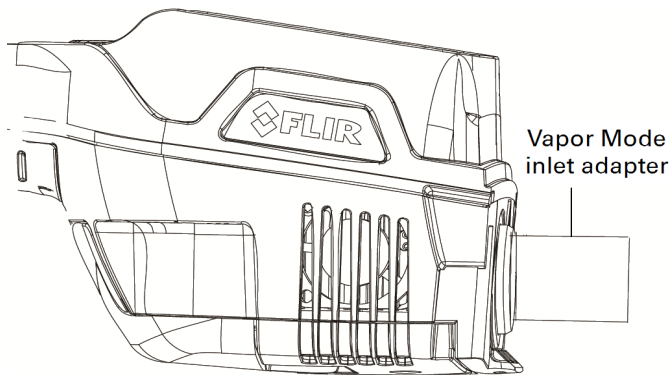

**Figure 5-23:** Presenting the Vapor Mode inlet adapter

**Step 3:** Select **Go** to begin verification. A countdown of 3 seconds will display, then a screen similar to Figure 5-24 will appear:

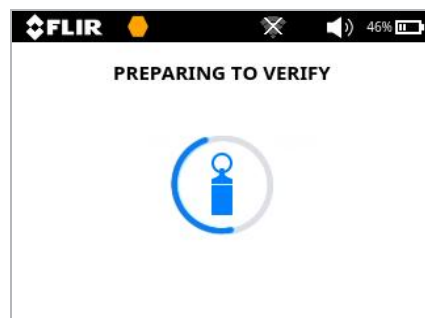

**Figure 5-24:** Preparing to Verify screen in Vapor Detection Mode

From this point on, verification proceeds in the same way as it does in Particulate Detection Mode. For more information, see 5.2 , p.31.

#### 5.4.5 Collecting a vapor sample

When system verification in Vapor Mode is complete, a screen like Figure 5-25 will appear. Select **Sample** or **Search** for the detection method you want. The two methods are described below.

**Note:** Depending on the Vapor Mode settings, both Sample and Search methods may not be available. See 5.4.2.



**Figure 5-25:** Selecting a vapor detection method

##### 5.4.5.1 Sample

The Sample method allows you to collect a controlled, targeted sample, such as from the headspace over a cup of liquid. When you select Sample, the system will display a count-down from 3, prompting you to present the sample. In the example of the cup, you would present the sample by positioning the detector inlet in or near the headspace. The sample presentation time will last for a maximum of 10 seconds or until on-screen prompts direct you to remove the sample.

Alarm results in Vapor Detection Mode resemble those for Particle Mode. For more information, see Step 6 of Section 5.3.3, "How to sample" and Section 5.5, "Sample Information."

**Note:** Due to chemical and environmental principles, it is less likely in Vapor Mode to be able to identify a threat at a category or specific substance level. The detection algorithm implemented for the vapor sample method focuses on general threat detection and false alarm reduction.

##### 5.4.5.2 Search

Search allows you to monitor system response graphically, in real time, through the display. When you select **Sample**, a graph which represents the response of each channel in the

sensing element (see 3.5.1), along with alarm thresholds, is displayed. The type of graph is determined by the Fido X4 Vapor Mode settings (5.4.2).

Search mode does not provide category- or substance -level threat identification. Its main purpose is for sorting out possible threats from "noise."

## 5.5 Sample Information

You can access additional information for any sample by selecting the **Info** option after an analysis result is displayed.

### 5.5.1 Sample information: no threat detected

If no threat was detected, the sample information screen will resemble Figure 5-26:

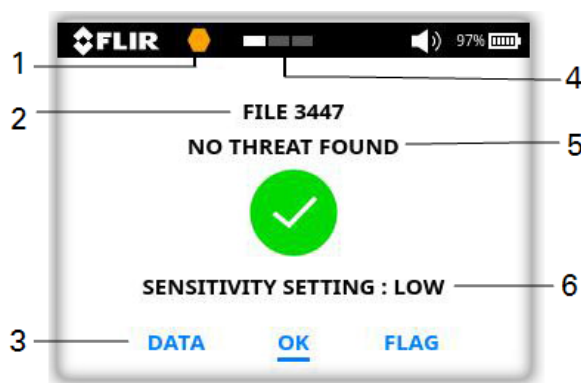

**Figure 5-26:** Sample information screen: No threat detected

Information type	Comments	
1	Sensing element type	
2	Unique file number	
3	Commands <ul style="list-style-type: none"> <li>• Select <b>Data</b> to view the raw sensor array data in the form of a spectrogram. See 5.5.3.</li> <li>• Select <b>OK</b> to return to the analysis result screen.</li> <li>• Select <b>Flag</b> to flag the sample record. See 5.5.4.</li> <li>• Select <b>ID</b> for more information on the threat. See 5.5.5.</li> </ul>	
4	Current Sensitivity setting	
5	Result of analysis	Displays the message "No threat found."
6	Sensitivity setting when sample was taken	

### 5.5.2 Sample information: threat detected

If a threat is detected, the sample information screen will resemble Figure 5-27.



**Figure 5-27:** Sample information screen: Threat detected

Information type	Comments
1 Sensing Element type	
2 Unique file number	
3 Alarm strength	Alarm strength is described by red triangles on a scale of 1 to 4 triangles, indicating the relative magnitude of the response, or quantity of the threat material collected (1= lowest, 4=highest).
4 Commands	<ul style="list-style-type: none"> <li>Select <b>Data</b> to view the raw sensor array data in the form of a spectrogram. See 5.5.3.</li> <li>Select <b>OK</b> to return to the analysis result screen.</li> <li>Select <b>Flag</b> to flag the sample record. See 5.5.4.</li> <li>Select <b>ID</b> for more information on the threat. See 5.5.5.</li> </ul>
5 Current Sensitivity setting	
6 Type of threat found	<p>The presumptive threat identification displayed may be at a general threat/ no threat level, threat material class, or at a specific substance level.</p> <p>Depending on the amount that was available for analysis and other factors, this presumptive threat identification may indicate only that a threat is present, the threat material class, or a specific substance.</p>
7 Sensitivity setting when sample was taken	

### 5.5.3 DATA command

Select **Data** from a sample information screen to view the raw sensor array data in the form of a spectrogram. An example is shown in Figure 5-28.

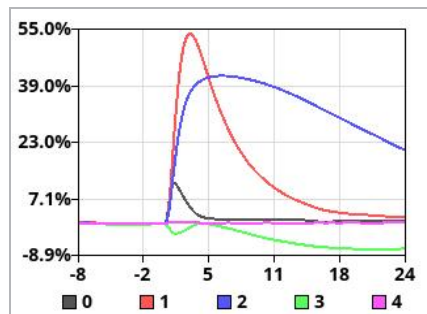

Figure 5-28: Spectrogram of a sample analysis

### 5.5.4 FLAG command

You can use the **Flag** command to flag any sample immediately after viewing the results or at any time later through the File Archive menu.

Flags are meant to provide some additional information about the sample that was collected.

There are multiple flag options to choose from:

- Red flag: Use to flag the record of a known threat material
- Green flag: Use for a sample record of a known blank or background
- Sample source flags: These are icons you can use to identify the source of a sample, including a person, vehicle, bag, or cargo container.

To see the different types of flags, highlight the **Flag** command on a sample information screen, then press  repeatedly.

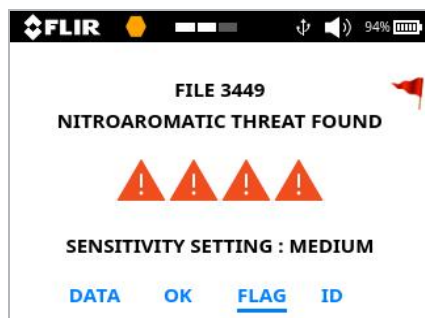
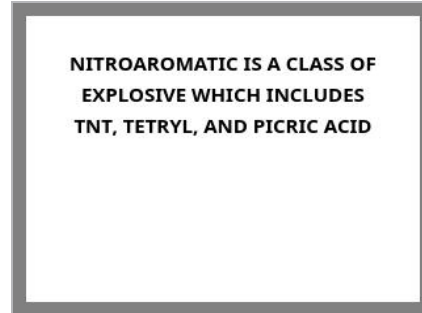

Figure 5-29: Flagged sample record

### 5.5.5 ID command

If a threat is detected, you can select **ID** from the sample information screen to display additional details about the threat that was identified.



**Figure 5-30:** Threat details displayed by ID command

## 5.6 Turn Off the Fido X4

Press the power button and hold to power down the Fido X4. A message will display to acknowledge that the power key has been pressed. A countdown will display to show progress toward initiating the shutdown sequence. If you release the power key before the countdown completes, the Fido X4 will cancel the shutdown sequence and return to the previous screen.

## 6 Reviewing Data

### 6.1 Reviewing Sample Data

You can access sample data at any time by clicking , then selecting **File Archive** from the Main Menu.

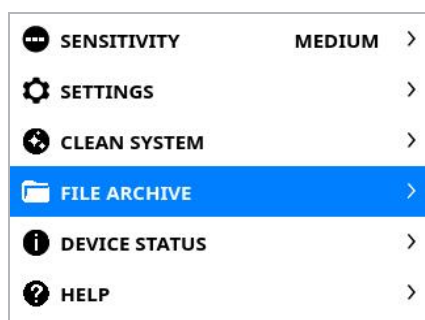

**Figure 6-1:** Navigating to the File Archive menu

You can view sample records individually or batch them into summary reports.

#### 6.1.1 Reviewing individual sample records

To review individual sample records:

- Step 1:** From the main menu, select **File Archive** to display the File Archive menu. **Browse Files** will be highlighted. Press  to select it.

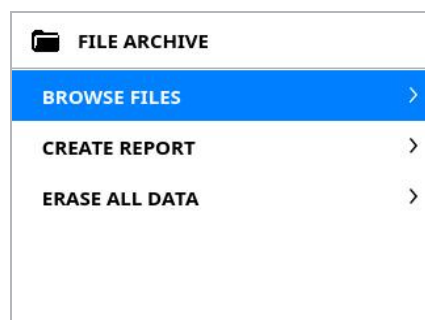

**Figure 6-2:** File Archive menu

- Step 2:** On the Browse Date screen, press  or  to navigate to the date you want. Press  to select the date.

BROWSE DATE		
11/24/2019	1443 - 1443	>
11/23/2019	1441 - 1442	>
11/22/2019	1380 - 1440	>
11/21/2019	1374 - 1379	>
11/20/2019	1321 - 1373	>

**Figure 6-3:** Selecting a sample record

**Step 3:** A new screen will appear, listing the file numbers (see "Sample Information" on p. 43) for the sample records created on the date you selected. Repeat the actions from Step 2 to select the record you want and press  to display the record.

## 6.2 Creating Reports

You can use the Fido X4 to generate reports, which include:



- all individual data files from each sample recorded during a time period you select, including screen captures from the original sample analysis
- .csv files for viewing the raw data
- a summary report, in PDF format, with sample statistics

To create a report:

**Step 1:** From the main menu, select **File Archive** to display the File Archive menu, then select **Create Report** to display the Choose Report menu.

CHOOSE REPORT		
DAY REPORT		>
WEEK REPORT		>
MONTH REPORT		>
ALL DATA REPORT		>
CUSTOM REPORT		>

**Figure 6-4:** Choose Report menu

**Step 2:** On the Choose Report menu, press  or  to navigate to the type of report you want. Press  to select it. A screen will appear to let you know the report



is being generated.

- If you select **Custom Report**, a screen will appear where you can select the date range for your report. Once you have selected the date range, the report will begin to generate.

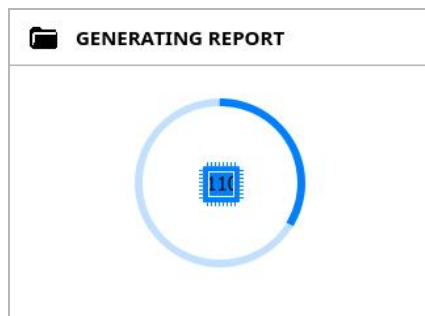

**Figure 6-5:** Report generation in progress

After a summary report is generated, it is temporarily stored on the device. Reports can be accessed by connecting the Fido X4 to a computer, using the USB-C to USB-A data cable. To conserve storage space, reports are erased from the device after a power cycle. For more information, see "Connecting to a Computer" on p. 51.

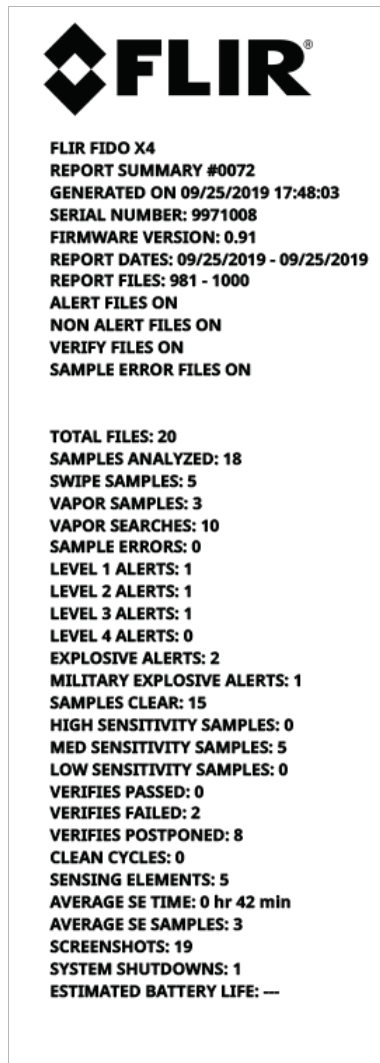

**Figure 6-6:** Summary report

### 6.2.1 Erasing data

The Erase All Data function on the File Archive menu deletes all data files from the instrument. The function should only be performed by an administrator, and requires an administrator passcode to activate. For information on administrator passcodes, see the *Fido X4 Administrator Guide*.

**Note:** To avoid data loss, back up Fido X4 files on a computer before erasing data. See "Connecting to a Computer" on p. 51.

## 7 Connecting to a Computer

The Fido X4 is compatible with USB 2.0 for Windows®, Mac®, and Linux® operating systems. When you connect the Fido X4 to a computer with the included USB cable, it functions as a drive, allowing you to update firmware, view product documentation, and access reports generated by the Fido X4.

The latest versions of the Fido X4 firmware and manuals can be found at the FLIR Detection Service and Support Portal: <https://flir.link/x4>.

### 7.1 USB Connection

Plug in the included USB cable to the Fido X4 USB port, then connect the USB end of the cable to your computer's USB port (see Figure 3-3).

The first time the Fido X4 is connected to a computer, there may be a delay as any necessary drivers are configured by the operating system. Once enabled, the Fido X4 will appear as a storage device and will be assigned a drive letter or resource identifier by the computer.

**Caution:** Data on the Fido X4 USB drive may be erased or overwritten during normal system operations. Do not use the Fido X4 to store other data files.

### 7.2 Wireless Connection

The Fido X4 can connect to a WiFi access point or tether to a Bluetooth device. For instructions, see the *Fido X4 Administrator's Guide*.

### 7.3 Updating Firmware

The firmware on the Fido X4 can be downloaded from <https://flir.link/x4>. Once you have downloaded the firmware, follow the instructions below to update it:

Step 1: Connect the Fido X4 using one of the methods above.

Step 2: Copy the firmware file onto the Fido X4 drive.

Step 3: Disconnect from the computer.

The Fido X4 will then read the firmware file, authenticate it, and update the firmware.

### 7.4 Reports

You can access reports from the Fido X4 drive while the Fido X4 is connected to a computer. For an introduction to Fido X4 reports, see "Creating Reports" on p. 48.

If a report is generated while the Fido X4 is connected to the computer via USB, the Fido X4 will briefly disconnect while the report is generated. The Fido X4 will then reconnect with the new report available.

Reports will normally remain on the Fido X4 unless the drive is full; however, using the Fido X4 as a permanent storage site is not recommended. For long-term storage, FLIR recommends that you copy or extract reports to another storage device on the attached computer.

## 7.5 Digital manuals

The Fido X4 stores a digital copy of this manual and other documentation in PDF format. You can save or copy these manuals to local storage on your computer to allow access to the documentation when the Fido X4 is not connected.

PDF reader software is likely installed on your computer. However, if you cannot open the PDF file, you may need to contact your organization's IT team. A common source of PDF reader software is Adobe, the creator of the format: <https://get.adobe.com/reader/>.

**Note:** For optimal display of the digital manuals, FLIR recommends you download the latest version of your PDF reader software.

## 8 System Maintenance

Fido X4 requires basic maintenance and cleaning to ensure optimal performance throughout operation. All basic maintenance can be completed by the end-user. Fido X4 does not require periodic calibration or factory-performed maintenance.

### 8.1 Replacing the Sensing Element

The sensing element will periodically need to be replaced. The Fido X4 determines when replacement is needed, based on Verification results and internal diagnostic parameters that are continuously monitored by the system. If the sensing element needs to be replaced, the Fido X4 will notify you during operation as described in Section 5.2.1, "Verification Failure."

**Note:** If possible, perform the procedures in this section over a raised soft surface (for example, a table covered with a towel) to minimize the risk of dropping the sensing element from a height and breaking it.

#### 8.1.1 Removing the sensing element



**Caution:** The sensing element is HOT.

Handle with care to avoid burns.

When handling the sensing element, take care only to touch the end of the Element that is marked with a dot (Figure 8-1).



**Caution:** Breaking a sensing element will create sharp edges and glass shards that can cut or puncture skin.

- Do not store sensing elements in clothing pockets.
- Do not put a sensing element where someone might sit or step on it.
- Properly dispose of used or broken sensing elements with care to avoid injury.

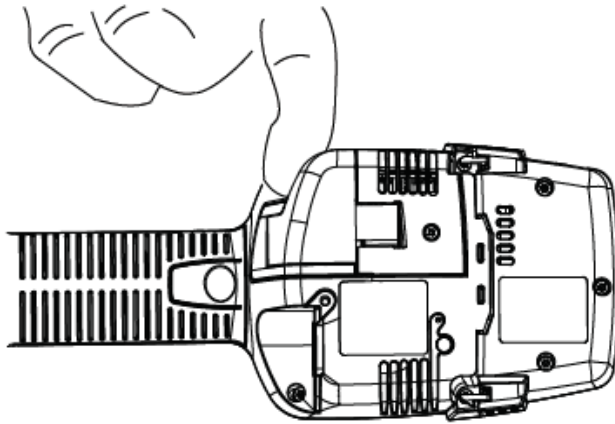

**Figure 8-1:** Dot (enlarged) on sensing element marks the area safe for handling

#### Procedure

**Step 1:** Turn the Fido X4 over so the underside is exposed, with the battery pointing toward you. Keep the unit horizontal as shown in Figure 8-2.

Step 2: Apply pressure from beneath the sensing element compartment door to pop open the latch, as shown in Figure 8-2.



**Figure 8-2:** Opening the sensing element compartment (1)

Step 3: Pull the door out horizontally, parallel to the Fido X4, as shown in Figure 8-4, until it is fully extended in that direction.

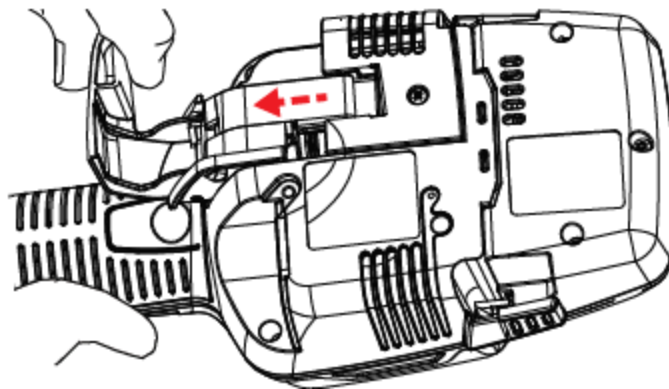

**Figure 8-3:** Opening the sensing element compartment (2)



**Caution:** Do not continue to the next step without fully extending the door in a horizontal direction as shown in Figure 8-4, or you may break the sensing element.

Breaking a sensing element will create sharp edges and glass shards that can cut or puncture skin.

Step 4: Tilting the head of the Fido X4 downward at an approximately 45-degree angle as shown in Figure 8-11, lift the sensing element door up to expose the sensing element.

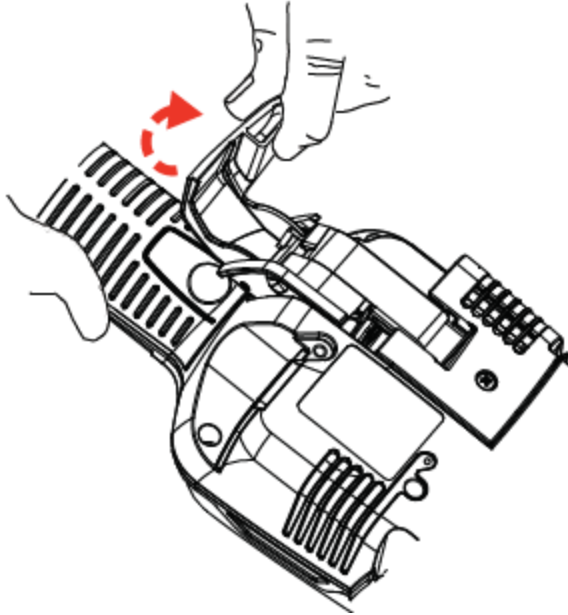

**Figure 8-4:** Accessing the sensing element

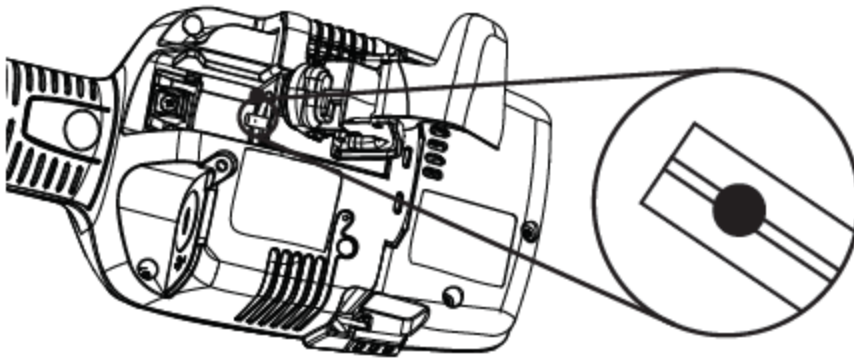

**Figure 8-5:** Sensing element in place



**Caution:** The sensing element is HOT.

Handle with care to avoid burns.

When handling the sensing element, take care only to touch the end of the Element that is marked with a dot (Figure 8-5).

Step 5: Carefully remove the sensing element and dispose of it safely.

### 8.1.2 Installing the sensing element



**Caution:** Breaking a sensing element will create sharp edges and glass shards that can cut or puncture skin.

- Do not store sensing elements in clothing pockets.
- Do not put a sensing element where someone might sit or step on it.
- Properly dispose of used or broken sensing elements with care to avoid injury.

Step 1: Verify that the sensing element type marked on the packaging is the type you want.

Step 2: Remove a new sensing element from the packaging.

Step 3: Hold it by the marked end (Figure 8-1).

Step 4: Insert the unmarked end into the sensing element compartment in the Fido X4 (see Figure 8-5).

Step 5: The sensing element will meet some initial resistance from the O-rings that it seats into. Push it gently until it is fully seated.

**Caution:** If you attempt to close the sensing element compartment door before the sensing element is fully seated, you may break the sensing element.

Step 6: Close the sensing element compartment door.

Step 7: Using the display, select the appropriate sensing element type, then select **Confirm** (Figure 8-6).

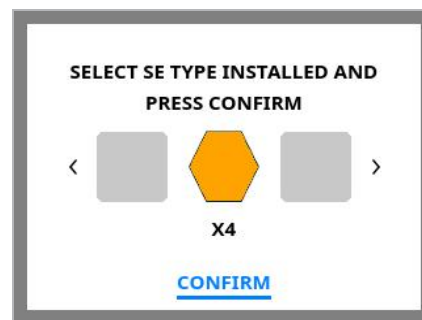

**Figure 8-6:** Selecting the sensing element type



## 8.2 Battery Handling



**Caution** Handle batteries appropriately.

- Use specified charger only.
- Do not incinerate or expose to high temperatures above 140°F / 60°C.
- Do not short-circuit.
- Do not put into fire. Dispose of properly.

### 8.2.1 Charging the battery

The Fido X4 battery can be charged during operation by plugging the AC wall adapter provided in the kit into the USB-C connector. Batteries may also be charged individually by using the external battery charging adapter, also included.

### 8.2.2 Replacing the battery

During operation it may be necessary to replace the Fido X4 system battery when the charge becomes low. The system will notify the user when the battery needs to be replaced.

The Fido X4 battery is hot-swappable, meaning the system does not need to be powered off to replace the battery. When the battery is removed, the system will display a timer, which indicates the amount of time (1 minute) allowed to install a new battery. Once a new battery is installed, the system will reinitialize and regular operation can continue.

#### 8.2.2.1 Removing the battery

Press the silver button on top of the battery pack to disengage the latch and remove the battery.

#### 8.2.2.2 Installing the battery

Line up the battery stem with the port on the system and insert until the battery clicks into place.

## 8.3 Maintenance Kit Contents

Each Fido X4 system kit includes a maintenance kit with supplies for basic maintenance. The maintenance kit includes:

- Inlet tool
- Inlet cleaning adapter w/ syringe
- Spare O-rings
- Cotton balls
- Cotton swabs
- Alcohol wipes
- Spare silica-treated inlet

## 8.4 Removing and Attaching the Thermal Desorber

The thermal desorber (TD) may be removed when operating in vapor detection mode (5.4.1) or for basic maintenance.

### 8.4.1 Removing the thermal desorber

To remove the TD:

**Step 1:** Using your thumb and index finger, press the silver tabs on each side of the TD (Figure 8-7).

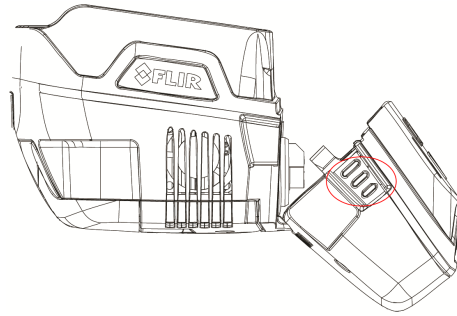

**Figure 8-7:** Squeeze tabs to loosen TD

**Step 2:** Once detached, lift the desorber free of the small tabs at the bottom.

**Step 3:** Place the TD on a clean surface, or back inside the system case.

### 8.4.2 Attaching the thermal desorber

To re-attach the TD:

**Step 1:** Insert the tabs on the bottom of the TD into the holes located on the main system housing.

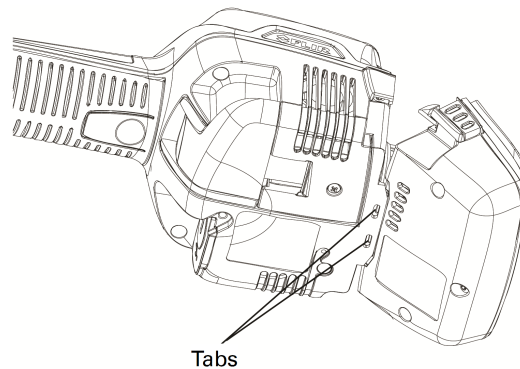

**Figure 8-8:** Attaching the TD

Step 2: Rotate the TD up to click the latches into place.

## 8.5 Replacing the Detector Inlet

The Fido X4 is equipped with a user-replaceable detector inlet (3.4.2 , p.17). The inlet should only need to be replaced in the event of a serious clog or physical damage. A spare detector inlet and additional O-rings are provided in the maintenance kit. The inlet can also be removed for cleaning.

### 8.5.1 Removing the inlet

Step 1: Power OFF the Fido X4 and allow 15 minutes for surfaces to cool.

Step 2: Remove the sensing element (see 8.1.1).

Step 3: Using the wrench component of the multi-purpose inlet tool provided in the maintenance kit, loosen the inlet by turning counterclockwise.

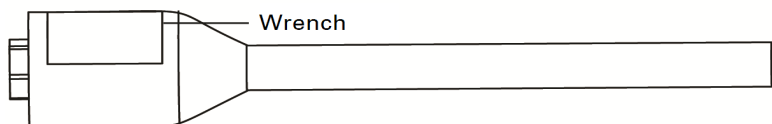

**Figure 8-9:** Inlet tool

Step 4: There are O-rings located inside of the inlet. Ensure they are accounted for before proceeding.

Step 5: Place the inlet on a clean surface.

### 8.5.2 Installing the inlet

Step 1: Ensure the O-rings are installed inside of the inlet.

Step 2: Thread the inlet onto the system by-hand by turning clockwise.

Step 3: Use the inlet tool to tighten.

Step 4: Do not over-tighten. The inlet will come to a hard stop when seated correctly.

Step 5: Power on the system and re-install a sensing element.

## 8.6 Cleaning the System

### 8.6.1 Clean System menu

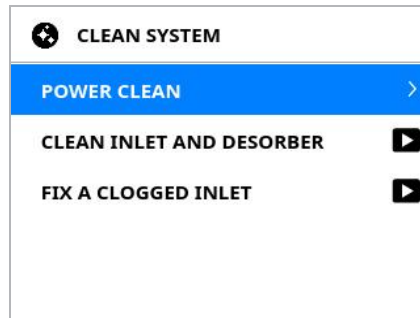

**Figure 8-10:** Clean System menu

Occasionally the Fido X4 system can become dirty or contaminated with residue or environmental contaminants. The Clean System menu provides instructions on how to clean the Fido X4 to ensure optimal performance throughout operation. There are two types of cleaning covered on this menu.

#### 8.6.1.1 Power clean

Power clean is the fastest option for cleaning the sensor inlet. Power clean is an automated function that elevates the exterior and interior temperature of the inlet to volatilize and remove residual contamination. This process takes about 7 minutes from start to finish and will require you to install a new sensing element once completed. For more information, see "Replacing the Sensing Element" on p. 53.

#### 8.6.1.2 Manual cleaning

Periodically, the Fido X4 should be cleaned manually. The manual cleaning frequency and schedule will depend on your operational environment and throughput; however, a general guideline is to perform manual cleaning once per week during periods of moderate to heavy usage.

FLIR recommends that manual cleaning be performed at the beginning or end of system operation to avoid disruptions in operational throughput.

The Clean System menu gives you access to two video tutorials on manual cleaning:

- Clean Inlet and Desorber
- Fix a Clogged Inlet

### 8.6.2 Cleaning the thermal desorber

Occasionally, the thermal desorber (TD) can become dirty or contaminated. This will adversely affect the performance of the Fido X4.

#### Materials needed

Alcohol swab or pad

#### Procedure

- Step 1: Power off the Fido X4 and allow 15 minutes for surfaces to cool.
- Step 2: Remove the TD by depressing the tab latches on each side.
- Step 3: Using an alcohol swab or pad, clean the circular metal surface and the plastic surrounding it.
- Step 4: Re-install the TD and power the system on.

### 8.6.3 Cleaning a clogged or dirty sensor Inlet

Rarely, it is possible to clog or contaminate an inlet sufficiently to require more thorough cleaning.

To clean the detector inlet:

- Step 1: Power off the Fido X4 and allow to cool for 15 minutes.
- Step 2: Use the inlet tool to remove the detector inlet tip as shown in the "Remove the Inlet" video, available from the Help menu.
- Step 3: Thread the inlet into the cleaning adapter (Figure 8-11).



**Figure 8-11:** Cleaning adapter

- Step 4: Fill the syringe with clean DI water or alcohol.
- Step 5: Slowly depress the syringe to force liquid through the inlet.
- Step 6: Discard solution appropriately.

**Step 7:** Remove the detector inlet from the cleaning adapter and place it on a clean surface.

**Step 8:** Allow the inlet to completely dry before re-installing.

#### **8.6.4 Other maintenance tasks**

You can access instructional videos for these processes from the Help menu 4.2.6

##### **8.6.4.1 Inspecting and replacing O-rings**

The singular detector flow-path is sealed using several silicon O-rings. Periodically, it is important to check the integrity of these O-rings to ensure there are no abrasions or tears which could introduce air leaks. Air leaks can negatively impact system performance.

With the system powered off and fully cooled down, remove the thermal desorber, sensing element and then the detector inlet. Visually inspect each O-ring for damage. Replace any damaged O-rings. Re-install the inlet and sensing element, leaving the thermal desorber removed.

##### **8.6.4.2 Checking the system for leaks**

Following the O-ring check and replacement, verify that there are no air-leaks. Use the silicon endcap of the inlet tool to create a face seal against the singular flow-path of the detector. This is done by firmly pressing the silicon end-cap into the concave area of the detector inlet. As airflow through the system drops, it is displayed on the device. The flow rate should reach 0 ccm during this process. By monitoring and checking that the flow rate on the device drops to 0, you can ensure that air is not entering the system through a leak, which would negatively impact performance during operation.

## 9 Understanding Alerts

When the Fido X4 indicates that possible explosives have been detected, it's important to understand what it means and have a plan in place to deal with the response.

When the Fido X4 indicates that explosives have been detected:

- Don't panic.
- Confirm and investigate.
- Follow your protocols.

### 9.1 Don't Panic

It is important that the operator of the Fido X4 be able to maintain awareness and presence of mind. Do not indicate to the person responsible of the item being screened that anything is wrong. Begin to observe body language, vocal intonation, and posture. Ask innocuous questions.

Questions like:

- "What do you think of the weather?"
- "How are you doing today?"
- "Where are you going today?"

These types of questions will help you observe behavior and buy time for further investigation.

If a person being screened produces an alert, it does not necessarily mean that they have had direct contact with explosives. They may have had inadvertent contact with explosives, or may have a legitimate reason for contact with an explosives related compound.

### 9.2 Confirm and Investigate

When an alert occurs it is important to make sure you understand the alarm. Select **Info** from the Threat Detected screen to learn more about the alarm.

For a complete anatomy of a threat screen, see "Sample information: threat detected" on p. 44.

**Confirm the alarm:** Once you understand the alert, it's important that you confirm the alarm. Using a fresh swipe, re-sample the area that gave you a previous alert. If the alert repeats, it is important to investigate the alert further.

**Investigate the alarm:** Once an alert has been confirmed a second time, it is important to try to determine the root cause of the alarm. There are legitimate reasons why a person might trigger an alarm.

For example:

- In many regions of the world, ammonium nitrate – which can be used as an explosive – is also commonly used as fertilizer. If a person has handled ammonium nitrate fertilizer, they might cause an alert.
- Since the Fido X4 detects the elemental sulfur in black powder, a person might have recently handled match heads, or vulcanized rubber (vehicle tires) which will cause an alarm.
- A person might be taking heart medication such as nitroglycerin or PETN, both of which are also explosives in spite of their medical applications.

### 9.3 Follow Organizational Protocols

Proper investigation and determining the root cause of the alarm is one of the most important tasks you can perform as an operator. You should follow established Standard Operating Procedures (SOP) or protocols set by your unit, organization, or company.



## 10 Specifications

### Fido X4 ETD Technical Specifications

Technology	FLIR TrueTrace®; five-channel fluorescence technology; no radioactive source
------------	--

### Sampling & Analysis

Sample Introduction	Swipes for particle collection and surface sampling; direct vapor for bottled liquids and UGV-based missions
Sampling Phase	Trace particulate and vapor
Threats	Detects military, conventional, homemade, and liquid explosives
Time to Alarm	10-25 seconds
Clear-Down Time	Less than 30 seconds

### System Interface

Display & Alerts	Visible, audible, and haptic (vibration) alerts; vivid, sunlight-readable color display (32k colors)
Localization	Language translation available worldwide
Communication	USB-C (data and communication modes), toggleable WiFi, and Bluetooth
Data Storage	3,500 hours of continuous data logging
Data Management	On-device report generation; export to mass storage
User Levels	Operator and Administrator mode

### Power

Input Voltage	100-240 VAC (wall adapter supplied)
Battery Specs	Up to 16-hour mission time; two rechargeable and hot-swappable Li-ion batteries, each lasting up to 8 hours
Startup Time	3 minutes from cold; <10 seconds from sleep

### Environmental

Operating Temperature	32 to 104 °F (0 to 50 °C)
Operating Humidity	5% to 95% non-condensing
Storage Temperature	14 to 122 °F (-10 to 60 °C)

### Physical Features

Dimensions (L x W x H)	14.5 x 4.5 x 2.8 in (37.0 x 11.5 x 7.0 cm) - with battery
Weight	3.2 lbs (1.5 kg)
Enclosure & Protection	IP54-rated, molded magnesium and polymer composite casing with anti-corrosive coating

### Unmanned Platform Integration

Kit Components	UGV mounting bracket, inlet and screen protection, battery port cover
----------------	---

## Table of Figures

Figure 3-1: Fido X4 Kit Contents .....	15
Figure 3-2: Fido X4 (front) .....	16
Figure 3-3: Fido X4 (back and right side) .....	17
Figure 3-4: Sensing element (dot enlarged) .....	19
Figure 3-5: Sample swipe .....	20
Figure 3-6: Reference standard, fully extended .....	20
Figure 4-1: Keypad .....	22
Figure 4-2: Example of a Command screen .....	23
Figure 4-3: Example of a Menu screen .....	24
Figure 4-4: Examples of configuration screens .....	24
Figure 4-5: Fido X4 main menu .....	25
Figure 4-6: Sensitivity menu .....	26
Figure 4-7: Settings menu with scroll bar .....	27
Figure 4-8: File Archive menu .....	27
Figure 4-9: Device Status menu .....	28
Figure 4-10: Help menu .....	29
Figure 5-1: Startup screen .....	30
Figure 5-2: Heating Up screen .....	30
Figure 5-3: Present Reference Standard screen .....	31
Figure 5-4: Incomplete verification warning .....	31
Figure 5-5: Extending the reference standard .....	32
Figure 5-6: Reference standard in TD slot .....	32
Figure 5-7: Checking System Performance screen .....	33
Figure 5-8: Verify Pass screen .....	33
Figure 5-9: First Verify Fail screen .....	34
Figure 5-10: Verify Fail screens .....	34
Figure 5-11: Replace sensing element alert screen .....	34
Figure 5-12: Reference Presentation Error screen .....	35
Figure 5-13: Examples of "first touch" areas .....	36
Figure 5-14: Bullseye design (not present on actual swipe) indicates Zone of Analysis .....	36
Figure 5-15: Examples of bad (top) and good (bottom) swiping technique .....	37
Figure 5-16: Insert Sample screen .....	37
Figure 5-17: Sample inserted in TD Slot .....	38
Figure 5-18: Gathering Particles screen .....	38
Figure 5-19: Analyzing Particles screen .....	39
Figure 5-20: Analysis result screens .....	39
Figure 5-21: System verification screen for Vapor Mode .....	40

---

Figure 5-22: Vapor Mode inlet adapter .....	41
Figure 5-23: Presenting the Vapor Mode inlet adapter .....	41
Figure 5-24: Preparing to Verify screen in Vapor Detection Mode .....	41
Figure 5-25: Selecting a vapor detection method .....	42
Figure 5-26: Sample information screen: No threat detected .....	43
Figure 5-27: Sample information screen: Threat detected .....	44
Figure 5-28: Spectrogram of a sample analysis .....	45
Figure 5-29: Flagged sample record .....	45
Figure 5-30: Threat details displayed by ID command .....	46
Figure 6-1: Navigating to the File Archive menu .....	47
Figure 6-2: File Archive menu .....	47
Figure 6-3: Selecting a sample record .....	48
Figure 6-4: Choose Report menu .....	48
Figure 6-5: Report generation in progress .....	49
Figure 6-6: Summary report .....	50
Figure 8-1: Dot (enlarged) on sensing element marks the area safe for handling .....	53
Figure 8-2: Opening the sensing element compartment (1) .....	54
Figure 8-3: Opening the sensing element compartment (2) .....	54
Figure 8-4: Accessing the sensing element .....	55
Figure 8-5: Sensing element in place .....	55
Figure 8-6: Selecting the sensing element type .....	56
Figure 8-7: Squeeze tabs to loosen TD .....	58
Figure 8-8: Attaching the TD .....	58
Figure 8-9: Inlet tool .....	59
Figure 8-10: Clean System menu .....	60
Figure 8-11: Cleaning adapter .....	61

# Index

---

## A

Administrator's Guide 26, 51

alerts 34, 63, 65

## B

battery 9, 11, 18, 30, 53, 66

## C

command screens 23

computer connection 51

    Bluetooth 51, 65

    USB 14, 49, 51, 57, 65

    wireless 51

## D

detector inlet 11, 17, 28, 30, 59

display 18, 22, 25, 30, 47, 52, 56, 65

## E

erasing data 50

## F

firmware 28, 51

    updating 51

flow rate 62

## H

Help menu 29, 61

---

## **K**

keypad 18, 22

kit contents 14

## **M**

maintenance 9, 14, 53

manuals 52

menu

    Help 29, 61

    Settings 26, 39

    Status 28

menus 18, 22, 25, 39, 47, 60

## **O**

O-rings 56

## **P**

PDF 48, 52

powering on 30

## **R**

records 47

reference standard 11, 14, 31

reports 18, 47, 51, 65

    accessing 18, 51

## **S**

safety 11

---

sample records

    reviewing individual 47

sample swipes 20

scroll bars 27

sensing element 11, 28, 30, 53

sensors 17, 28, 31, 60

Settings menu 26, 40

soft button 18

specifications 65

Status menu 28

support 9, 18

swipes 14, 28, 39

## **T**

technical support 9, 18

theory of operation 14

thermal desorber (TD) 11, 17, 30, 32, 58

thermal desorption module (TD) 17

## **U**

USB 14, 49, 51, 57, 65

## **V**

videos 9, 29, 31, 62

This document is changed in accordance with our Quality Management system. All changes are archived.

Publ. No.: 4226044

Revision: C

Language: en

Issue date: April 15, 2020

